

**Garmin**<sup>®</sup>

**MARINE  
INSTRUMENTS**



# Commander<sup>™</sup>

Tachometer/ Engine Hourmeter

## Owner's Manual

- Analog Tachometer  
Digitally displays
- Hours Engine Has Been Run
- Fuel Level
- Other Features if Available:
  - Fuel Management
    - Fuel Flow in GPH or LPH
    - Total or Trip Fuel Used
    - Low Fuel Alarm
    - Calculates Fuel Remaining In Tank
- Ambient Air/ Water Temperature

**ISO137**

ISO137D ECR#4851 08/04

<b>Installation</b>	
Smaller Connector	Page 1
Larger Connector	Page 1
<b>Operations</b>	
Lighting	Page 2
Tachometer	Page 2
Engine Running Only Hourmeter	Page 2
Fuel Level	Page 2
Other Features	Page 3
Set-Up Mode	Page 3
Tachometer Selection	Page 4
<b>Fuel Management</b>	
Installation guide (Fuel Flow Transducer)	Page 5
Fuel Flow	Page 6
Units per Hour selection	Page 6
Fuel Used	Page 6
Reset	Page 7
Calibrate	Page 7
Total Fuel Used	Page 7
Reset	Page 7
Fuel Remaining	Page 8
Adjust Fuel Remaining	Page 8
Fuel Remaining Alarm	Page 8
Fuel Level	Page 9
<b>Bombardier® SystemCheck®</b>	
Discription	Page 10
Engine Temperature	Page 10
Oil Level	Page 10
Oil Flow	
Four Stroke engine	Page 10
Two Stroke engine	Page 10
Check Engine	Page 10
Operating Modes	
Self Test	Page 10
Normal Mode	Page 10
Diagnostic Mode	Page 11
<b>Ambient Air and Water Temperature</b>	
Discription	Page 12
Water Temperature	Page 12
Air Temperature	Page 12
<b>Figure 1</b> Fuel Management LCD Display Modes	Page 9
<b>Figure 2</b> Air/Water LCD Display Modes	Page 12
<b>Figure 3</b> Tachometer Set-Up	Page 14
<b>Table 1</b> Tachometer Seleccion Table	Page 15
<b>Table 2</b> Fuel Sender Selection Table	Page 15
<b>HN0355</b> Larger connection Air/Water Temp.Wire Diagram	Page 13
<b>HN0356</b> Smaller Socket Connection Wire Diagram	Page 16
<b>HN0354</b> Larger connection Fuel Management Wire Diagram	Page 17
<b>HN0358</b> SystemCheck Wire Diagram	Page 18-19

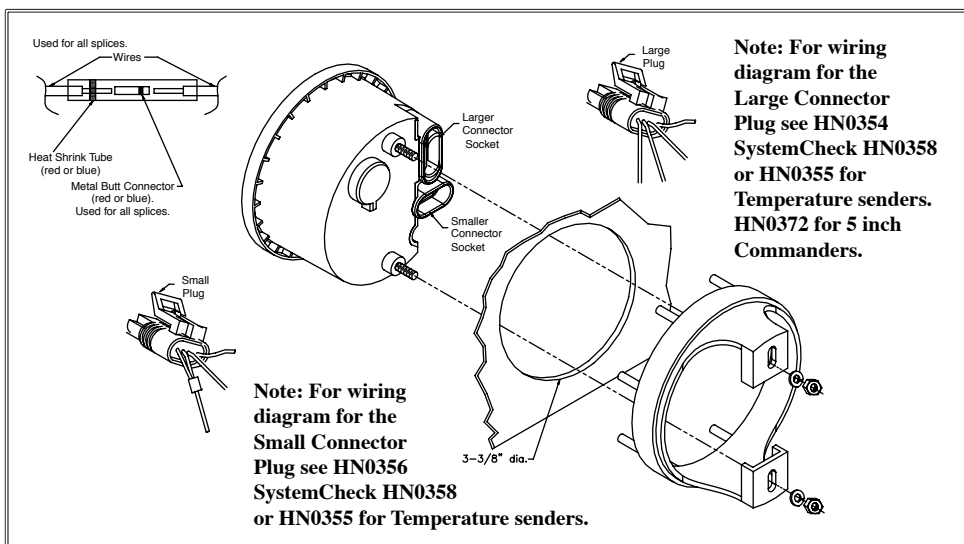

**This manual for 4 or 5 inch Commanders with**

- 1) Tach/Hour/Fuel Flow.
- 2) Tach/Hour/SystemCheck®/Fuel Flow.
- 3) Tach/Hour/Ambient Air/Water Temperature.

## Installation:

**CAUTION:** Disconnect the battery during installation. Tighten nuts on the backclamp only slightly more than you can tighten with your fingers. **Six inch-pounds** of torque are sufficient. Over-tightening could result in damage to the instrument and may void your warranty.

**1. Cut a 3-3/8" diameter hole** in the dash and mount the gauge with the backclamp supplied.

Follow the enclosed instructions for installing the sender. Once the sender is installed and you have run the cables to the Commander, connect the wires from the sender to the corresponding Small or Large connectors as illustrated using the butt connectors supplied. The butt connectors have a heat activated waterproofing. Once the butt connections have been crimped slowly apply heat with a heat gun until you see sealant coming

out of the connector ends. It is recommended to wrap the connections together with electrical tape for further protection.

### 2. Small Connector Socket Tachometer with Fuel Flow

Follow the wiring diagram at the end of this manual for wiring connections. HN0356.

SystemCheck® connections can be found on HN0358.

### Tachometer with Ambient Air and Water Temperature.

Follow the wiring diagram at the end of this manual for wiring connections. HN0355.

### 3. Large Connector Socket

#### Tachometer with Fuel Flow

Follow the wiring diagram at the end of this manual for wiring connections. HN0354.

SystemCheck® connections can be found on HN0358.

#### Tachometer with Ambient Air and Water Temperature.

Follow the wiring diagram at the end of this manual for wiring connections. HN0355 or HN0372 for 5 inch Commanders..

## Description

The Commander has three push buttons;

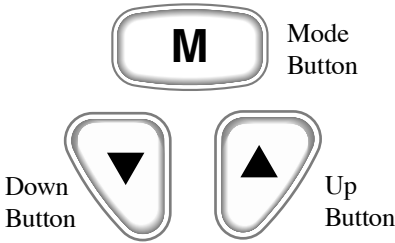

These buttons control the modes of operation. The “Mode” button is used to change the function of the LCD display and to access sub menus and adjustable settings. The “Up” and “Down” buttons are used to modify the settings.

In normal operation mode, pressing the “Mode” button quickly causes the display to cycle between the different instrument displays. Pressing and holding the “Mode” button causes the display to change to the “settings” sub menus (see Figure 1).

When the settings menus have been selected, pressing the “Mode” button quickly causes the display to cycle through the setting options. Within each setting selection, pressing the “Up and “Down” buttons causes the affected setting to change.

**Note: The microprocessor will automatically record the new settings as you adjust them.**

When in a setting menu, pressing and holding the “Mode” button returns to the main function.

The Tachometer and Fuel Level functions have several values that can be adjusted to match your installed equipment. These rarely used settings are changed in the **Set-Up Mode** (see Set-Up Menu guide below).

## Operation

### Lighting

In normal operating mode the instrument lighting can be adjusted by pressing the “Up” and “Down” buttons.

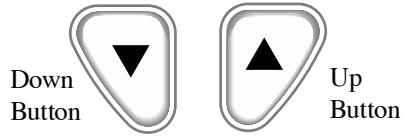

### Tachometer

The tachometer is a digital instrument with the appearance of an analog instrument. The tachometer is preset at the factory for an eight cylinder engine and a 6000 RPM dial. The setting for the tachometer can be changed in the **Set-Up** menu (see below).

A microprocessor controlled stepper motor moves the pointer to display engine revolutions per minute using a linear dial

### Engine Running Only Hourmeter

The Engine Hours display shows the number of hours the engine has been operated (Hr). The reading is based on a signal being received at the tachometer input to indicate that the engine is running.



Units are displayed as:



### Fuel Level

The Fuel Level display shows the amount



of fuel in the fuel tank in percent of full (PC). The indication is based on the fuel level sender in the tank and operates



similarly to a normal fuel gauge. There are no adjustments to this reading.

**Note: For proper operation no additional fuel gauges may be connected to the fuel level sender.**

### Other Features

The Commander can have special features programmed in it at the Factory.

1) Fuel Management which includes, Fuel Flow, Fuel Used, Total Fuel Used, and Fuel Remaining.

2) Ambient Air and Water Temperature.

This manual covers both. Refer to your boats owners manual for which feature have been installed.

## Setup Mode

Tachometer settings and the fuel level sender type can be changed using the Setup Mode (see Figure 2, Table 1, and Table 2). Use this option only if you have reason to believe that your settings are wrong. Setting an incorrect value in these menus can result in extremely inaccurate performance of the tachometer and fuel level sender.

To access the Setup Mode, press and hold both the “Up” and “Down” buttons while turning on the instrument.

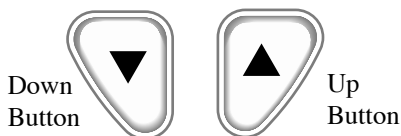

The display will show,



Briefly pressing the “Mode” button will cycle through the menu items.



The “Up” and “Down” buttons are used to modify the settings.

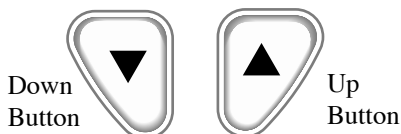

The microprocessor will automatically record the new settings as you change them.

Pressing and holding the “Mode” button sets the instrument to normal operation.



### Tachometer Selection

Refer to Figure 3 and Table 1 for an explanation of each of the tachometer selections.

#### T SCALE-

The “TAC 1” - “TAC 7” settings are normal engine tachometer settings based on different engine options found on most boats. Using “Up” and “Down” buttons, adjust the setting to match the engine in the boat as shown in **Figure 3**.

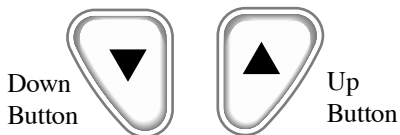

The “TAC 8TH” setting is normally used on diesel engines with a magnetic pick-up measuring the number of teeth on the flywheel of the engine. When this option is selected, the “TEETH” submenu is available.



Using the “Up” and “Down” buttons, adjust the number shown in the “TEETH” display until the number matches the published number of flywheel teeth for the engine.

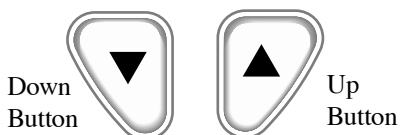

The “TAC 9VA” setting is normally used when a belt driven alternator supplies the tachometer signal OR when no other method of selecting the tachometer mode gives correct readings.

A digital or mechanical reference tachometer is needed to use this option. When this option is selected, the “VARIABLE” submenu is available.

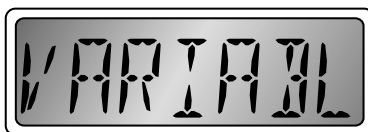

Connect the reference tachometer as required. Operate the engine at a convenient RPM as high as can be safely maintained.

Using the “Up” and “Down” buttons, adjust the number shown in the display to match the reference tachometer.

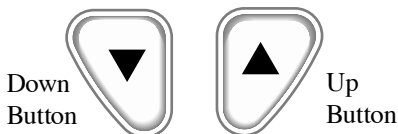

The tachometer pointer should also match the reference tachometer.

#### SENDER

Allows you to set the type of sender you are using. See Figure 3.

Set up is now complete.

# Installation Guide for the fuel flow transducer

## IMPORTANT

Always install the Fuel Flow Transducer AFTER the primary filter. The primary filter must be a good quality water separator type with a minimum filtration of 30 microns or better. (10 or 2 micron. The lower the micron rating the finer the filtration) Failure to provide this level of filtration protection will result in inaccurate readings or total failure or damage to the transducer. If there is not a suitable length of hose after the primary filter, an in-line filter (30 micron or better) should be fitted before the Fuel Flow transducer. Damage due to insufficient filtration is not covered by warranty. If in doubt please consult your local Marine dealer for advice prior to installation.

## Wiring Connection

- Keep electrical and transducer cables away from alternator or other noise generating electrical cables.



## Installation of the fuel flow transducer

The fuel flow transducer is designed for installation in Coast Guard approved  $\frac{3}{8}$ " flexible fuel line. The transducer MUST be installed AFTER the main fuel filter. It should be located well away from any area where it will be effected by excessive heat or vibration from the engine. It is preferable to mount the transducer in a vertical position.

Drain all the fuel from the flexible fuel line. Cut the fuel line and using the fuel hose attaching clips provided install the transducer so that the FUEL IN side of the transducer connects to the fuel tank.

# Fuel Management Functions

## Description

The Faria Commander Tachometer/ Fuel Monitor/ Engine Hourmeter combines the features of several instruments into one unit. The LCD displays the information for the other instruments:

- 1) **Fuel Flow** - Displays current fuel usage in Gallons or Liters per hour.
- 2) **Fuel Used** - Displays fuel used since last reset (trip fuel meter).
- 3) **Total Fuel Used** - Displays fuel used since last reset (total fuel meter).
- 4) **Fuel Remaining** - Displays the fuel remaining since last set (based on fuel flow).
- 5) **Fuel Level** - Displays fuel level in fuel tank (based on level sender) in percent.
- 6) **Engine Hours** - Displays the number of hours the engine has been run.

## Fuel Flow



The Fuel Flow display shows current fuel consumption in gallons per hour (G) or liters per hour (L).

The fuel flow sensor can be calibrated if necessary using the Fuel Used “settings” menu (see Fuel Used description below). The units displayed may be changed using the submenu. Pressing and holding the “Mode” button causes the display to change to the “UNITS” submenu (see Figure 1).



Mode Button

## Fuel Flow “UNITS” Menu

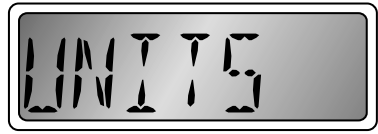

Pressing the “Up” and “Down” buttons will change the setting between GH and LH.

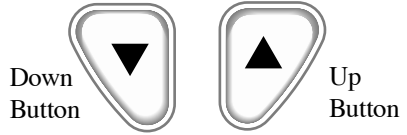

## Fuel Used

The Fuel Used display shows the amount of fuel used since the gauge was reset.



The display is based on the fuel flow system and therefore filling the fuel tank will not disturb the reading. The Fuel Used gauge may be reset to zero and the Fuel Used and Fuel Flow system calibrated using the sub menus.



Pressing and holding the “Mode” button



causes the display to change to the “settings” submenu (see Figure 1).

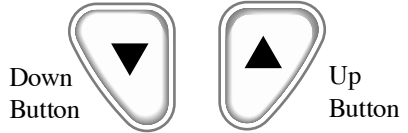

### Fuel Used “Settings” Menu

There are two items in the Fuel Used “Settings” Menu; Reset and Fuel Calibration. Briefly pressing the “Mode” button cycles through the menu items. The microprocessor will automatically record the new settings as you adjust them.



### Reset



Pressing the “Up” and “Down” button resets the Fuel Used gauge to zero.

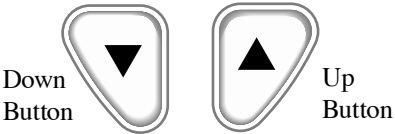

### Calibration

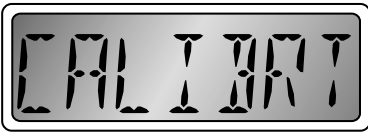

If you know “exactly” how much fuel you have used since the Fuel Used gauge was reset you can adjust the amount and therefore the Fuel Flow sensor calibration in this “setting” menu.

Pressing the “Up” or “Down” buttons changes the “amount of fuel used” display.

When the displayed quantity matches the amount of fuel you know you have used, calibration is complete.

### Total Fuel Used



The Total Fuel Used display shows the amount of fuel used since the Total Fuel Used gauge was reset.

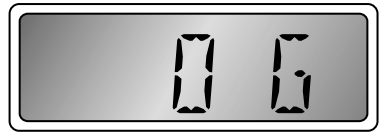

This gauge is useful for keeping track of fuel usage over a longer period of time or distance than the Fuel Used gauge. The display is based on the fuel flow system and therefore filling the fuel tank will not disturb the reading.

The Total Fuel Used gauge may be reset to zero using the submenu. Pressing and holding the “Mode” button causes the display to change to the “settings” submenu (see Figure 1).



### Total Fuel Used “Settings” Menu

There is one item in the Fuel Used “Settings” Menu; Reset.

## Reset



Pressing the “Up” or “Down” button resets the Total Fuel Used gauge to zero.

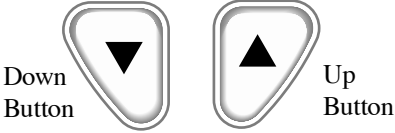

## Fuel Remaining



The Fuel Remaining display shows the amount of fuel remaining in G or L.



This display is based on your manually entered information (see Adjust Fuel Remaining below) and the accumulated Fuel Flow data since the gauge was adjusted. This information is not obtained from the fuel sender in the fuel tank and therefore is not affected by the boats position or angle as the fuel sender may be.

There is an alarm which may be set to warn of a low fuel condition. The amount of Fuel Remaining and the Fuel Remaining Alarm may be adjusted using the submenu. Pressing and holding the “Mode” button causes the display to change to the “settings” submenu (see Figure 1).



## Fuel Remaining “Settings” Menu

There are two items in the Fuel Remaining “Settings” Menu; Adjust Fuel Remaining and Fuel Remaining Alarm.

Briefly pressing the “Mode” button cycles through the menu items.



The microprocessor will automatically record the new settings as you adjust them.

## Adjust Fuel Remaining



When you fill the fuel tank or add fuel, you make a reasonable (or “exact”) estimate of the amount of fuel you have. Using this menu item you can enter (adjust) the amount of fuel remaining to your known (or estimated) amount. Pressing the “Up” or “Down” buttons will change the indicated Fuel Remaining.

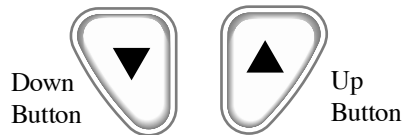

## Fuel Remaining Alarm



This alarm may be set to warn you when there is only a certain amount of fuel remaining according to the Fuel Flow usage calculation. Pressing the “Up” or “Down” buttons will change the Fuel Remaining Alarm setting.

## Fuel Level



The Fuel Level display shows the amount of fuel in the fuel tank in percent of full (PC). The indication is based on the fuel level sender in the tank and operates similarly to a normal fuel gauge. There are no adjustments to this reading.

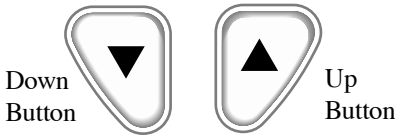

## Fuel Management LCD Display Modes

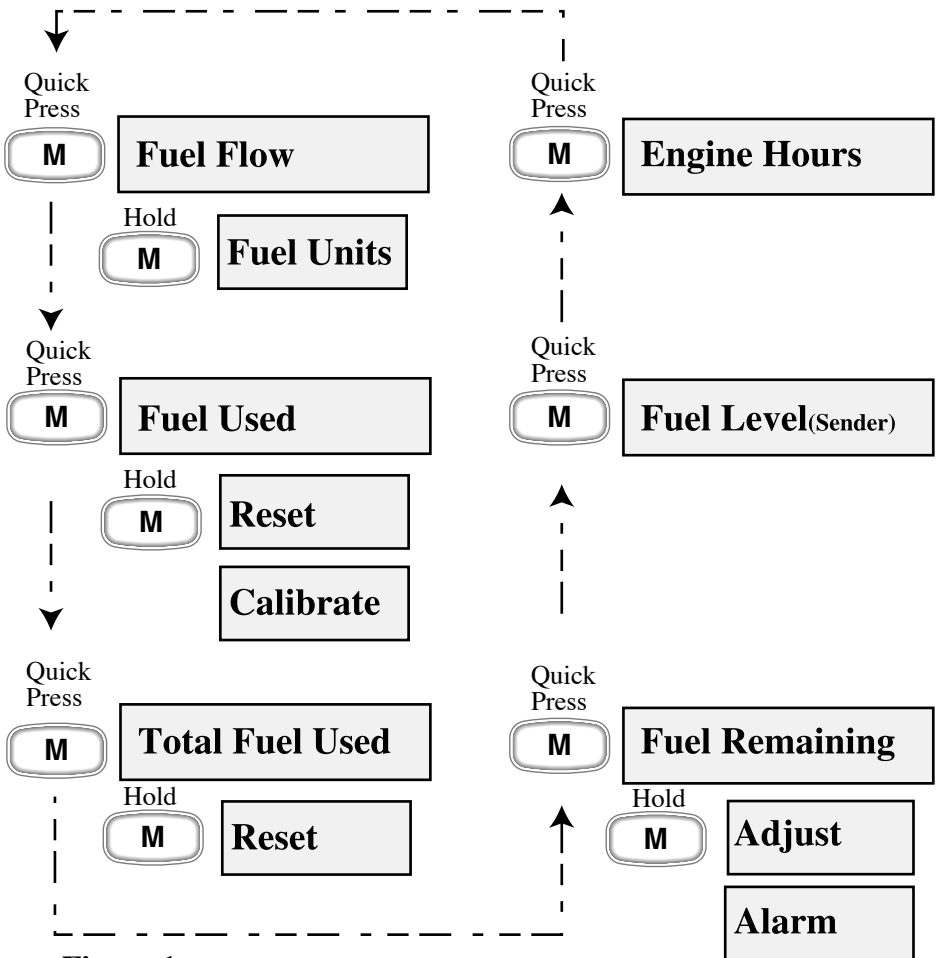

Figure 1

# Bombardier® SystemCheck®

## Description

The Bombardier SystemCheck is a system that monitors Evinrude® and Johnson® outboard engine sensors, providing clear audible and visual indications whenever a fault occurs.

The system monitors engine temperature, oil level, oil flow, oil pressure, and fuel restriction. In addition, the ECM (Engine Control Module) can activate a warning indication. Not all sensors are present on all engines.

For information about the wiring of the Commander to the SystemCheck harness can be found on HN0358 in this manual.

## Engine Temperature:

The displayed warning is “ENG HOT”:

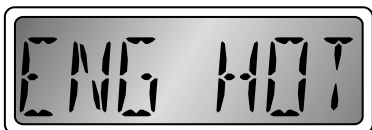

## Oil level:

The sensor is a mechanical float switch in the 2 cycle oil reservoir.

The displayed warning is “LO OIL”:



## Oil Flow:

*Four stroke engine:* An oil pressure switch is used.

*Two stroke engine:* An oil flow sensor is used to detect oil flow out of the oil injection system.

The warning will be displayed as “NO OIL”:



## Check Engine:

For fuel injected engines, the EMU generates the warning based on several fault conditions. For non-injected V6 outboard engines, a vacuum sensor is fitted in the fuel line. This is used to detect a blocked fuel line or fuel filter. (Non-injected engines without the vacuum sensor will not display this function.)

The warning will be displayed as “CHK ENG”:

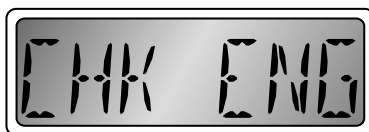

## Operating Modes

There are three operating modes for SystemCheck systems, self test, normal, and diagnostic.

### Self test:

On power up (key on), a limited self-test is performed to inform the operator that the system is active. The test activates the audible alarm and all warning messages. During the self test, the audible alarm sounds for 1/4 second. At the same time, the unit begins displaying all of the warning messages. Each warning message is displayed for 1 second. When all four messages have been displayed, the self test is complete.

**Normal mode:** This mode occurs when two conditions are met. The self test must be complete, and the engine must be running in excess of 200 R.P.M. In this mode, any fault detected will result in an audible and visual alarm. Both will commence simultaneously.

The audible alarm will sound for 10 seconds. The visual warning will be displayed for as long as the fault conditions exist.

If the engine stops running, but the key switch remains on, the unit will automatically go to “Diagnostic” mode.

**Diagnostic mode:** Simple diagnostics can be done with the key on, engine off. The intent is to aid the service technician in troubleshooting wiring or sensor problems. It can also be used to verify a system when there is no engine on the boat. In this mode, the following assumptions are made:

- 1) The key switch is on.
- 2) There is no tachometer signal (the engine is not running).
- 3) When the key switch is turned on, the self-test will be performed as usual.

After the self test is completed, the technician can ground any sensor input lead. The system will immediately display the fault condition associated with that input. The audible alarm is not sounded in this mode. In the event of a wiring error, it would be possible for multiple inputs to be grounded. In that case, the unit will display the multiple messages.

# Ambient Air and Water Temperature

## Description

The Faria Commander Tachometer/ Water-Air Temperature/ Fuel Level/ Engine Hourmeter combines the features of several instruments into one unit. The LCD displays the information for the other instruments:

- 1) **Water Temperature** - Displays the current water temperature.
- 2) **Ambient Air Temperature** - Displays shows current air temperature
- 3) **Fuel Level** - Displays fuel level in fuel tank (based on level sender) in percent.
- 4) **Engine Hours** - Displays the number of hours the engine has been run.

## Water Temperature

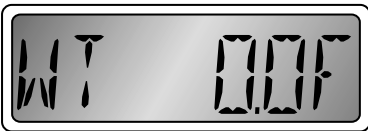

The Water Temperature display shows current water temperature based on a Faria supplied temperature probe. The probe must be mounted so as to always be submerged to the depth desired. There are no adjustments for this function.

## Air Temperature

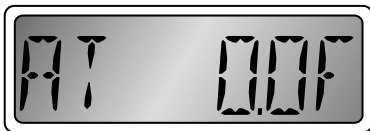

The Air Temperature display shows current air temperature based on a Faria supplied temperature probe.

The probe must be mounted so as to be exposed to free air but preferably not in direct sunlight. There are no adjustments for this function.

## Fuel Level

See description above.

## LCD Display Modes

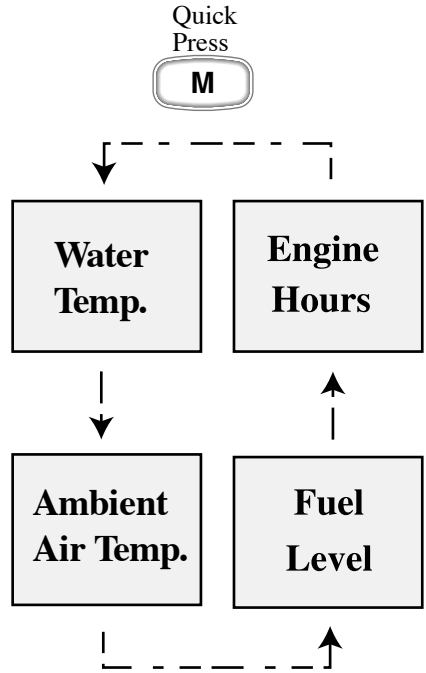

Figure 2

# Harness HN0355/HN372

## Large Connector

### Air/Water Temp.

#### HN0355 - 4 inch Commanders

Pin A	Red	Air Temperature
Pin B	Black	Ground
Pin C	White	Water Temperature
Pin D	Pink	Fuel Tank Sensor

ECR 1903 12/21/01

#### HN0372 - 5 inch Commanders

Same as above- Add the following

Pin E	Plug	Not Used
Pin F	Plug	Not Used

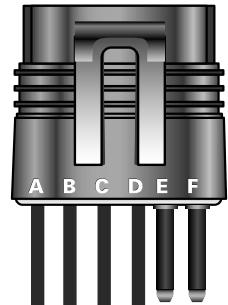
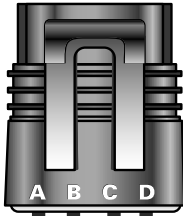

2x  
PJ0005

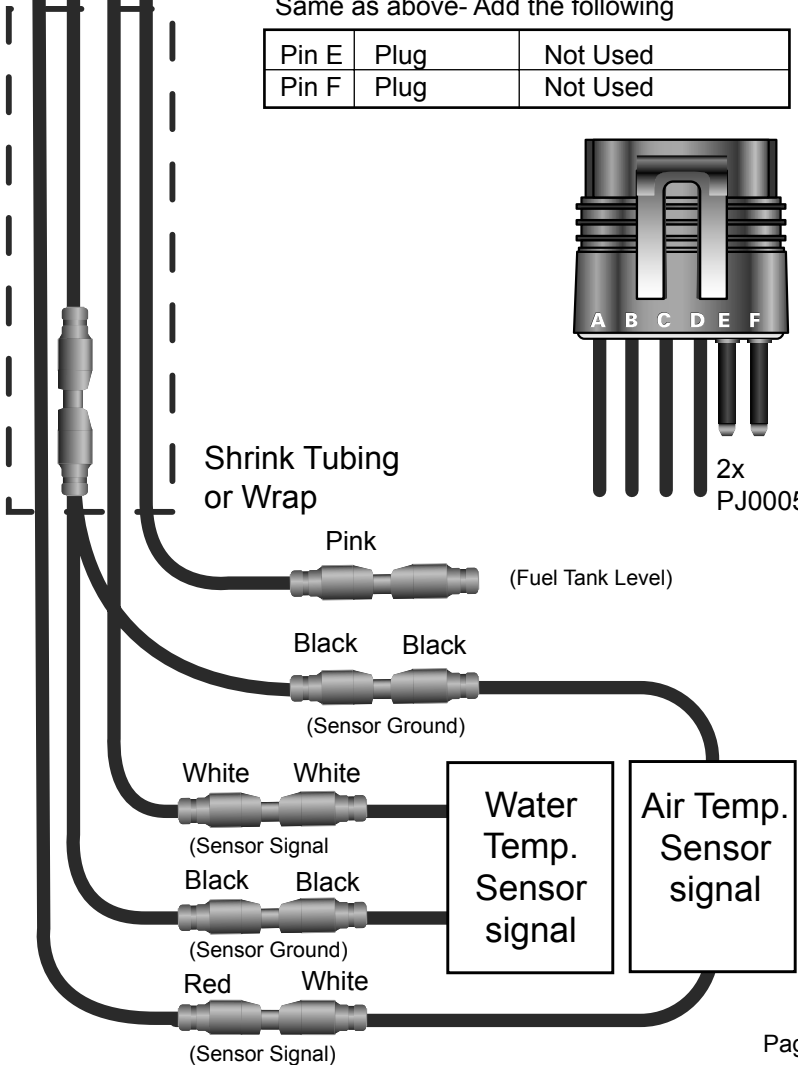

## Tachometer Full Scale Selection

Refer to Figure 3 for an explanation of each of the tachometer full scale selections.

This is normally a factory setting that needs no adjustment. The setting adjusts the “full scale” operating range of the tachometer to match the dial on the instrument. Using the “Up” and “Down” buttons, adjust the setting to match the maximum reading on the tachometer dial, 4000, 6000, or 7000 RPM.

## Fuel Level Sender Selection

Refer to Figure 3 and Table 2 for an explanation of each of the fuel level sender selections. Using the “Up” and “Down” buttons, adjust the setting to match the fuel level sender installed in the fuel tank.

### Set-Up Mode

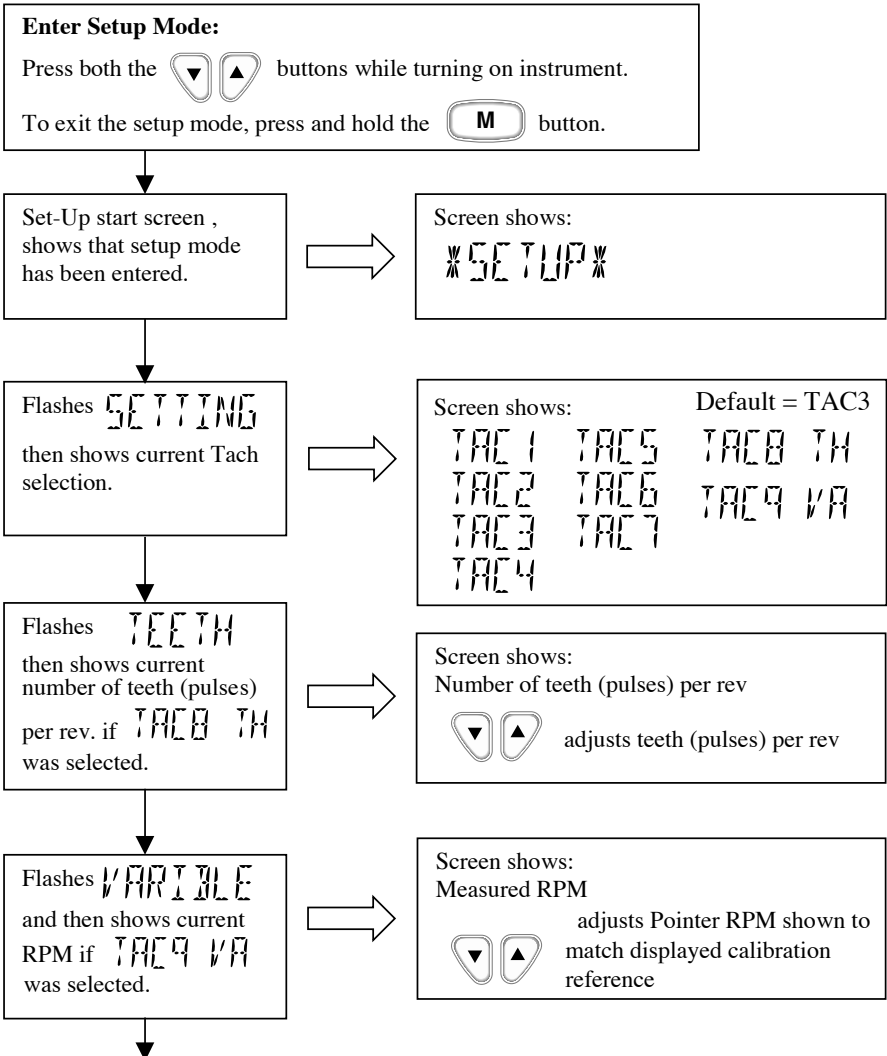



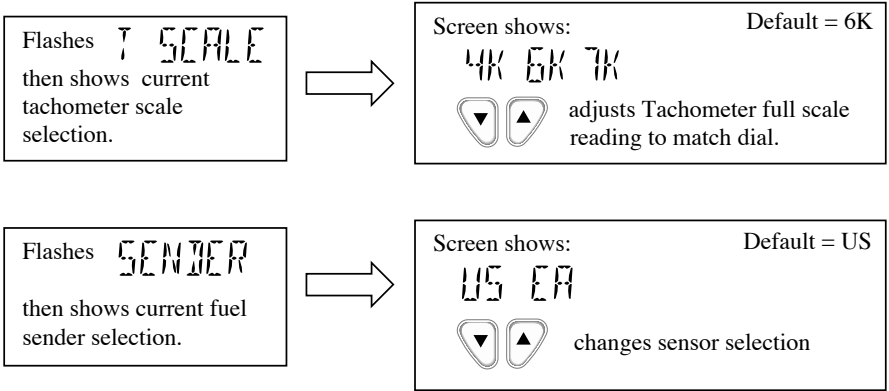

**Figure 3**

**Tachometer Selection Table**

TAC 1	Two pulses per rev. (4 cylinder, 4 cycle gas engine)
TAC 2	Three pulses per rev. (6 cylinder, 4 cycle gas engine)
TAC 3	Four pulses per rev. (8 cylinder, 4 cycle gas engine)
TAC 4	Five pulses per rev. (10 pole alternator on outboard engine)
TAC 5	Six pulses per rev. (12 pole alternator on outboard engine)
TAC 6	Eight pulses per rev. (Not Used)
TAC 7	Ten pulses per rev. (20 pole alternator on outboard engine)
TAC 8 TH	Two to Two Hundred Fifty pulses per rev.
TAC 9 VA	Match reference calibration digital or mechanical tachometer

**Table 1**

**Fuel Sender Selection Table**

US	Standard United States fuel sender ( 240 – 33 Ohms )
EU	Standard European fuel sender ( 10 – 180 Ohms )

**Table 2**

# Harness HN0356

## Small Connector

To Commander

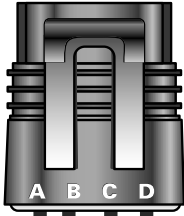

Small Plug(CN0082)

Pin A	Purple	+12 Ignition Power
Pin B	Purple	+12 Ignition Power
Pin C	Black	Ground
Pin D	Gray	Tachometer Input

ECR 1903 12/21/01

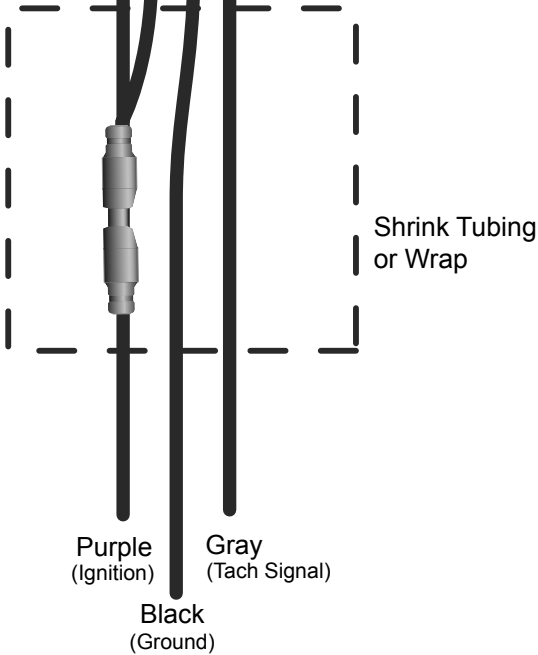

# Harness HN0354 Large Connector

To Commander

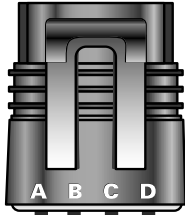

Large Plug(CN0082)

Pin A	Red	Fuel Flow Power
Pin B	Green	Sender Grounds
Pin C	White	Fuel Flow Signal
Pin D	Pink	Fuel Tank Level

ECR 1903 12/21/01

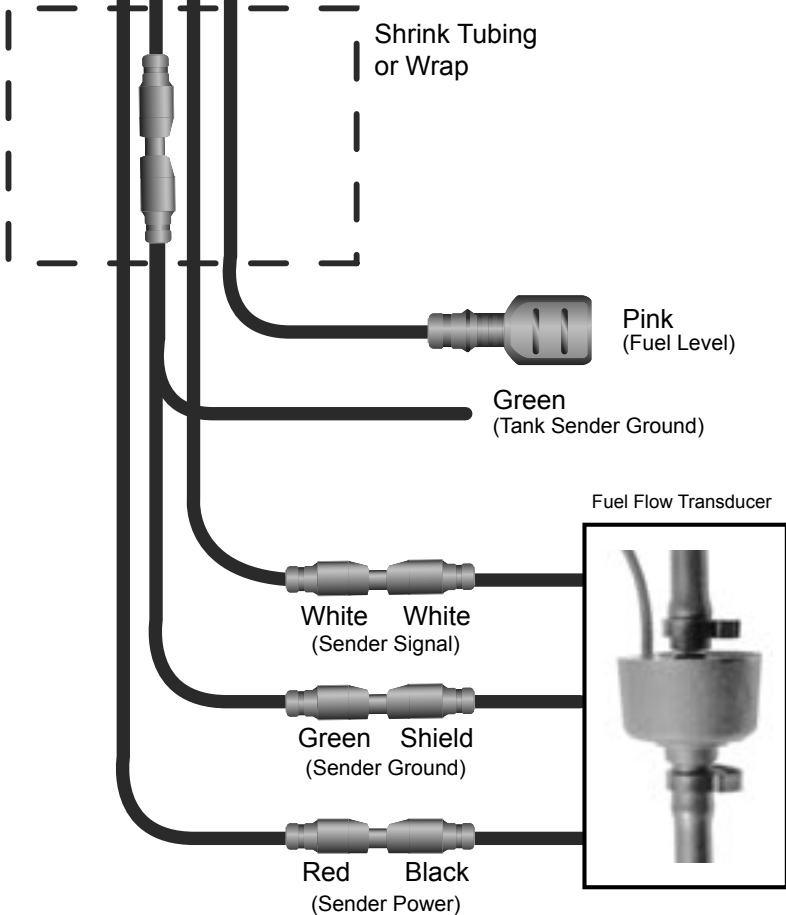

# Harness HN0358

## Small Connector

### SystemCheck® adaptor

Small connector(CN0082)

To Small  
Connector  
Socket

Pin A	Purple	+14 Ignition
Pin B	Tan/Orange	Check Engine
Pin C	Black	Ground
Pin D	Gray	Tachometer Signal

ECR 2275 4/15/02

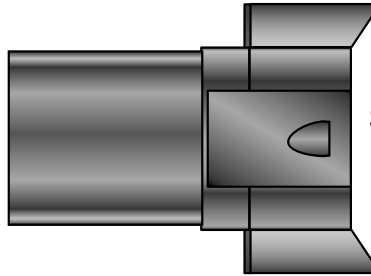
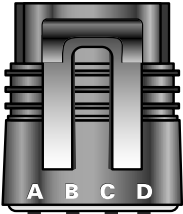

SystemCheck®  
Harness

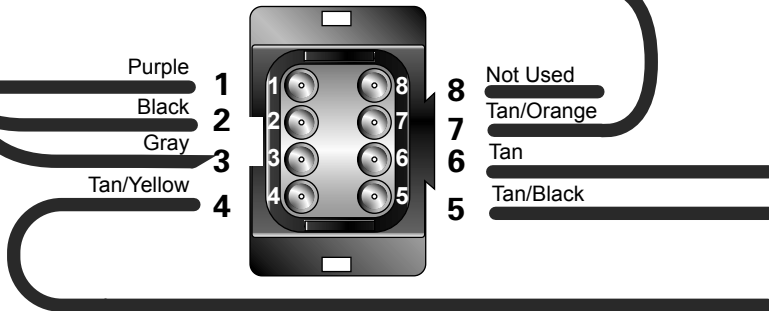

SystemCheck® Harness Deutsch Connector

Pin 1	Purple	+14 vDC Ignition
Pin 2	Black	Ground
Pin 3	Gray	Tachometer Signal
Pin 4	Tan/Yellow	No Oil Sensor
Pin 5	Tan/Black	Low Oil Sensor
Pin 6	Tan	Over Temperature
Pin 7	Tan/Orange	Lo Oil Sensor
Pin 8		Not Used

ECR 2275 4/15/02

# Harness HN0358

## Large connector

### SystemCheck®

#### Large connector(CN0083)

Pin A	Red	Fuel Transducer Power
Pin B	Tan	Over Temperature
Pin C	White	Fuel Transducer Signal
Pin D	Pink	Fuel Tank Level
Pin E	Tan/Black	Low Oil Sensor
Pin F	Tan/Yellow	No Oil Sensor

ECR 2275 4/15/02

To Large  
Connector  
Socket

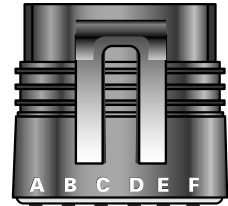

Tan (Over Temperature)

Tan/Black (Lo Oil Sensor)

Tan/Yellow (No Oil Sensor)



Fuel Flow Transducer

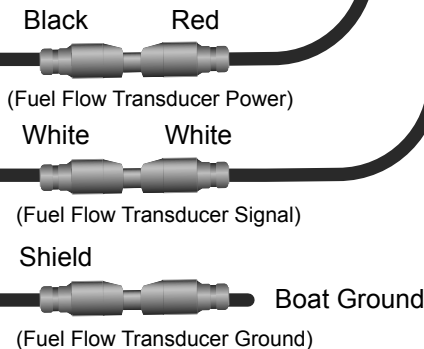

Pink  
(Fuel Tank Level)

Copyright 2004 by the Thomas G. Faria Corporation, Uncasville CT

No part of this publication may be reproduced in any form, in an electronic retrieval system or otherwise, without the prior written permission of the company.

Faria® is the trademark of the Thomas G. Faria Corporation

SystemCheck®, Evinrude®, Johnson®, and Bomardier® are trademarks of Bombardier Motor Corporation of America.